

Upsilon

[FI] Asennus- ja huolto-ohje
 [UK] Installation and maintenance instructions
 [SE] Installations- och underhållsinstruktioner

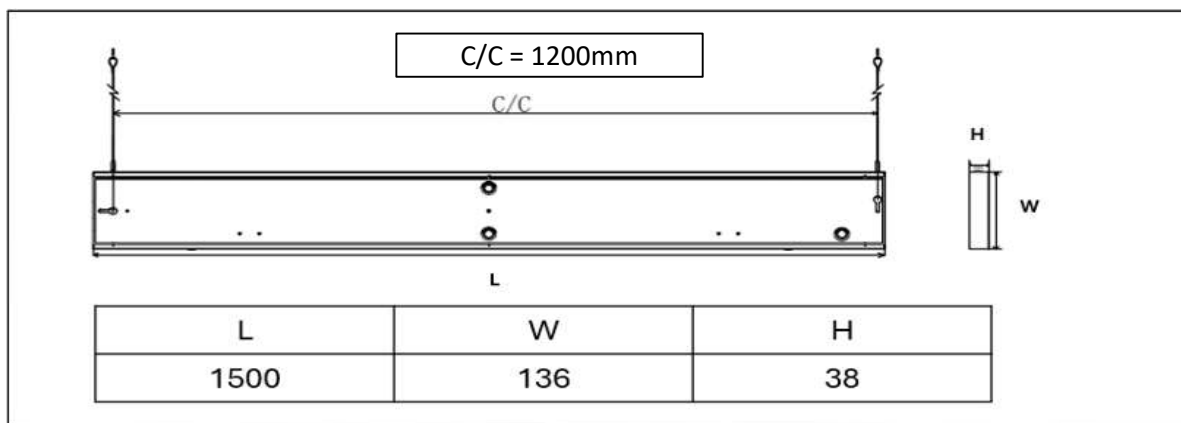
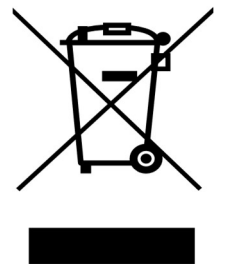
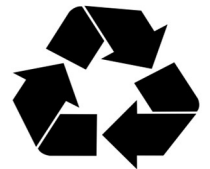
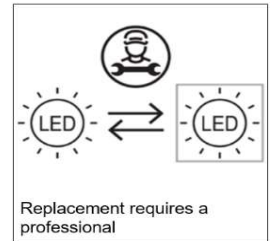
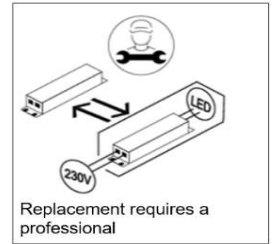

Copyright Greenled Oy
Greenled Oy
 Oritkarintie 4
 90400 Oulu Finland
 p. 020 125 5800
info@greenled.fi

FI	Nämä ohjeet tulee säilyttää ja luovuttaa kiinteistön käyttäjälle.
UK	It is appropriate that this information is passed on to the user of the installation.
SE	Det är lämpligt att denna information överlämnas till användaren av anläggningen.

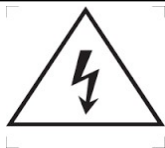

Turvallisuusvaroitukset:

Ennen asennusta tai huoltotyötä kytke valaisin irti sähköverkosta välttääksesi sähköiskun vaaran!

- Asennus / huoltotyön saa tehdä vain valtuutettu henkilö
 - Valaisimen asennuksen / huoltotyön saa suorittaa vain pätevä henkilö näiden ohjeiden mukaisesti.
 - Valmistaja ei kannu vastuuta valaisimen väärästä käytöstä
 - Älä katso suoraan päällä olevaan valaisimeen
 - Valaisimen valonlähteen saa vaihtaa ainoastaan Greenled, Greenledin valtuuttama huoltaja tai vastaavan pätevyyden omaava henkilö
-

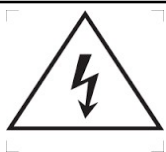

Safety notes:

Before installation or change work disconnect the power to reduce electrical shock risk!

- Installation / maintenance can only be done by a skilled personnel
 - Installation / maintenance of luminaire must be performed by qualified person following the instructions given in the instruction set
 - The manufacturer bears no liability for damage caused by inappropriate use or application
 - Do not stare at the operating light source
 - The light source contained in this luminaire shall only be replaced by the Greenled or Greenled's service agent or a similar qualified person
-

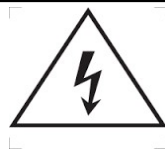

Säkerhetsvarningar:

Koppla alltid bort armaturen från elnätet i samband med installation ti den som använder armaturen.

- Installations- ocn underhållsarbeten får endast utföras av en behöring installatör
 - Installations-/underhållsarbetet får endast utföras enligt dessa anvisningar av en person med tillräckliga kunskaper
 - Tillverkaren ansvarar ej för felaktig användning av armaturen
 - Titta aldrig rakt in i en påslagen armatur
 - Ljuskällan inuti armaturen får endast bytas av antingen Greenled, en Greenled-auktoriserad servicetekniker eller en person med motsvarande kompetens
-

1. Wiring

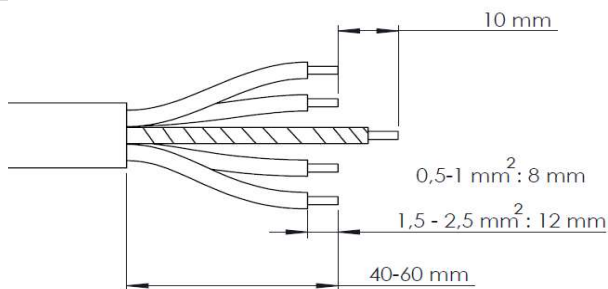

The luminaire is always equipped with a 3,6m 5x0,75mm² connection cable

ON/OFF
 L = Ruskea, Brown, Brun
 N = Sininen, Blue, Blå
 PE = Kelta-vihreä, Ground wire, Jordledning

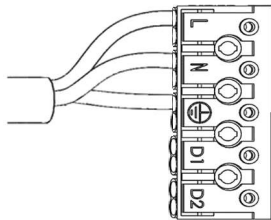

DALI
 L = Ruskea, Brown, Brun
 N = Sininen, Blue, Blå
 PE = Kelta-vihreä, Ground wire, Jordledning
 D1 = Musta, Black, Svart
 D2 = Harmaa, Grey, Grå

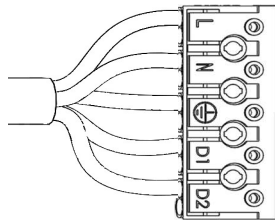

Driver BK-DAL040-1050Ad

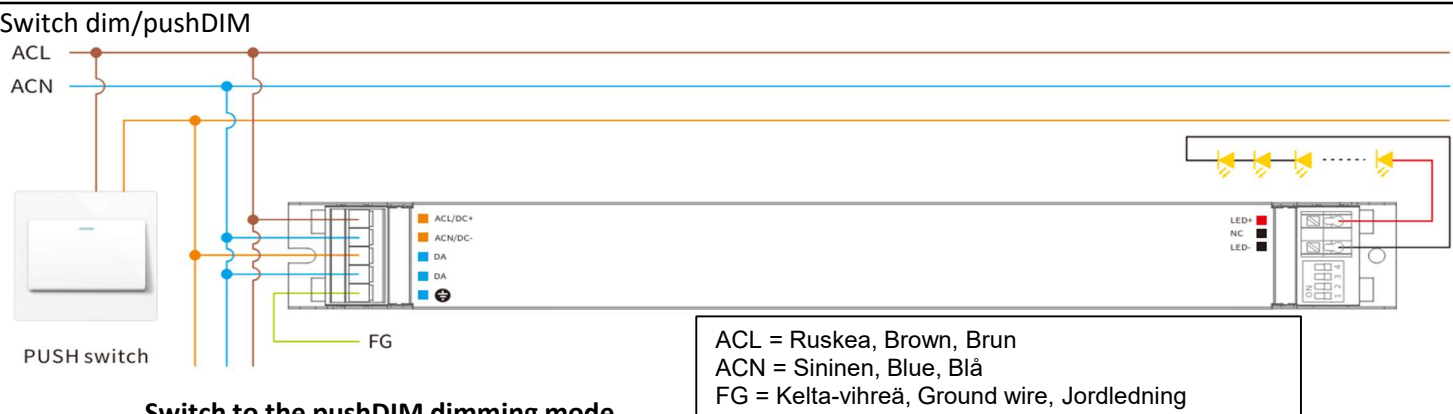
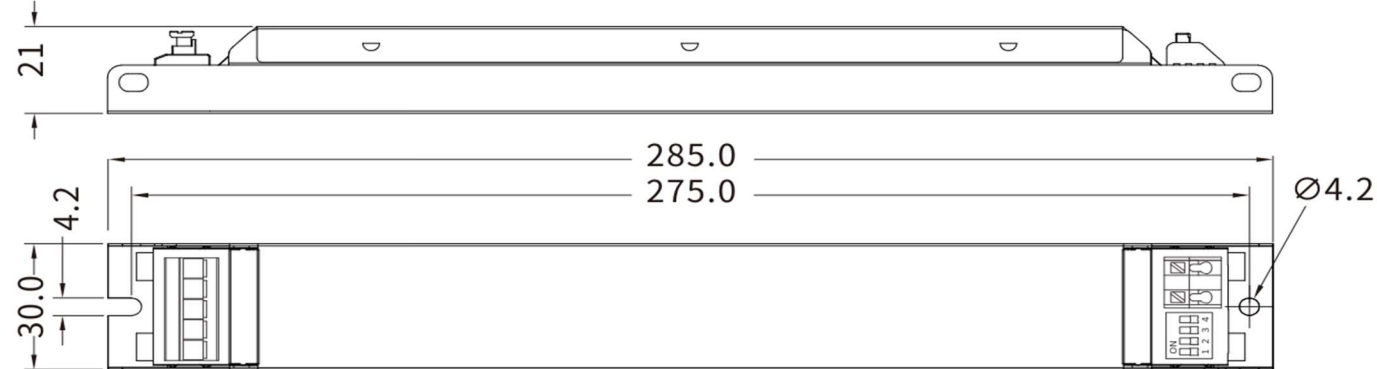

ACL = Ruskea, Brown, Brun
 ACN = Sininen, Blue, Blå
 FG = Kelta-vihreä, Ground wire, Jordledning

Switch to the pushDIM dimming mode

After installation according to the wiring diagram of pushDIM dimming application, long press the pushbutton 3 seconds, the driver will automatically switch to the pushDIM dimming mode.

Remarks:

- Max. 50 drivers per pushDIM control line.
- Turn on or turn off: short press pusbutton for 0,2-1s.
- Dimming: long press pushbutton for 1-5s.

2. DIP switch

Standard UP-Down 41W(1050mA) / 33W(800mA) power can be changed from DIP switches

Standard Direct 33W(800mA) / 27W(650mA) power can be changed from DIP switches

Output			1	2	3	4
Prated(w)	Irated(mA)	Voltage(Vdc)				
27.30	650	6-42	--	--	--	ON
33.60	800	6-42	ON	--	ON	--
39.90	1050 ★	6-38	--	--	--	--



3.1. Instructions for suspension installation

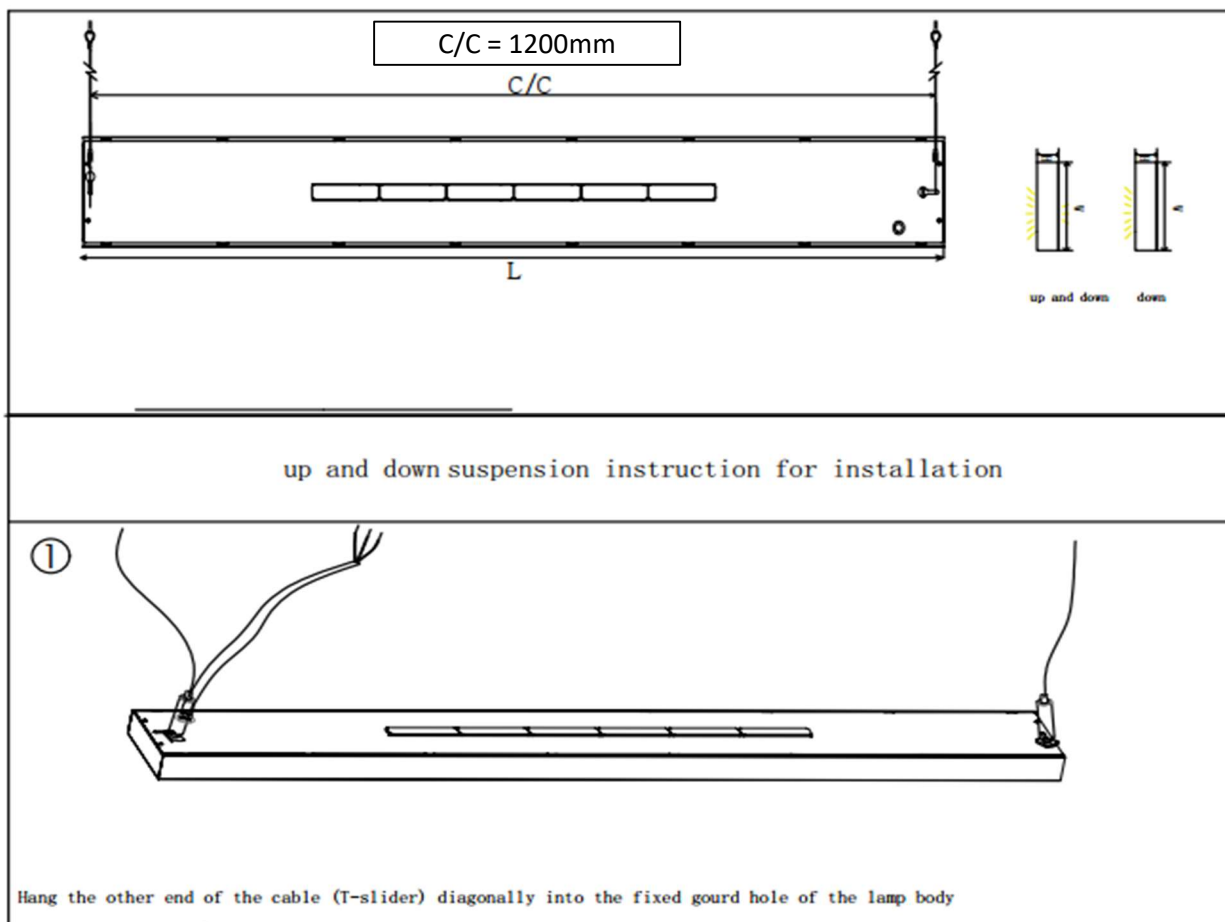

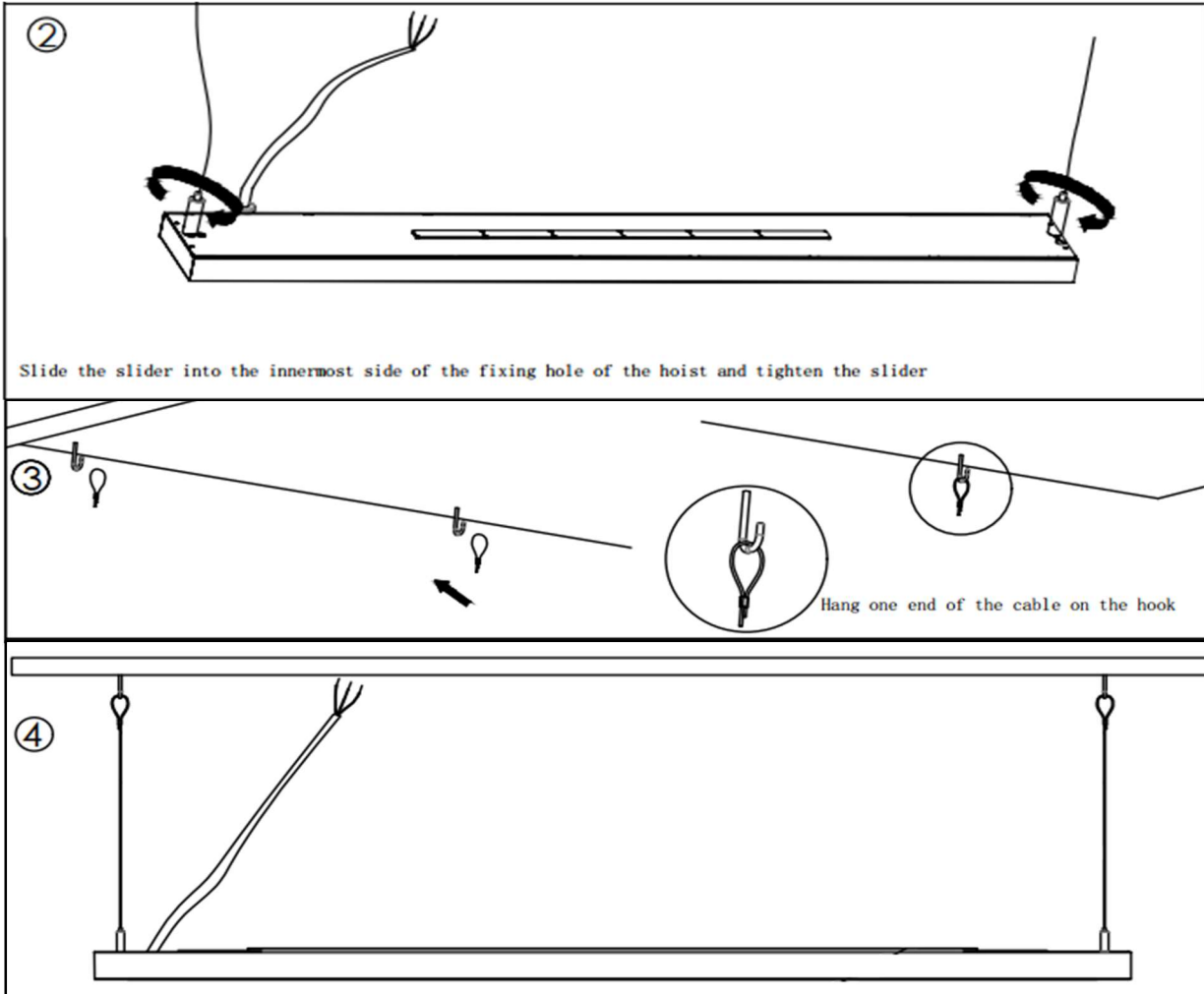

3.2. Instructions for surface mounted installation

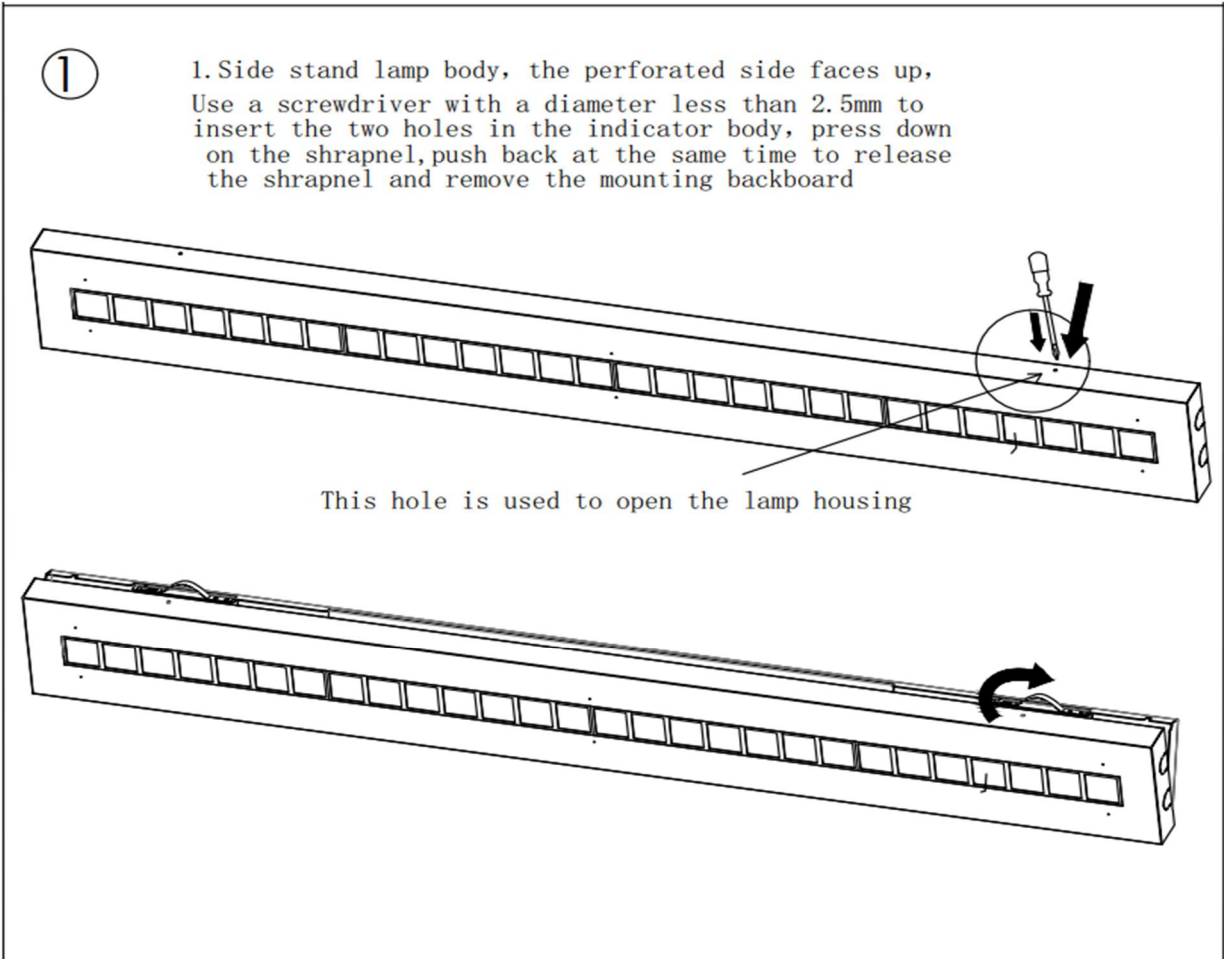

②



Screw in the expansion screws

Drive the expansion screws into the ceiling, that the position of the two screws need in a straight line, and the distance is accurate.

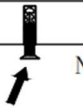
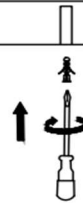

Note: Do not screw in the expansion screw completely

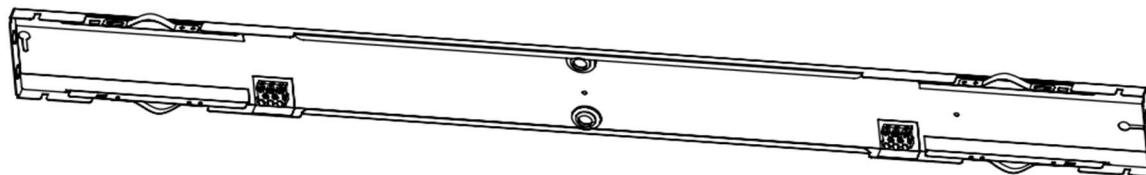
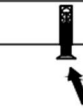

Insert the screw into the hole on the back of the lamp housing, a-b.

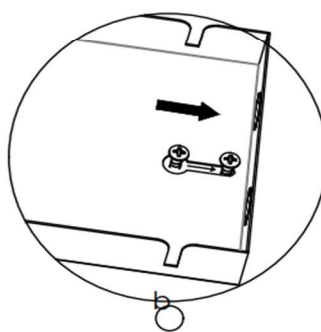
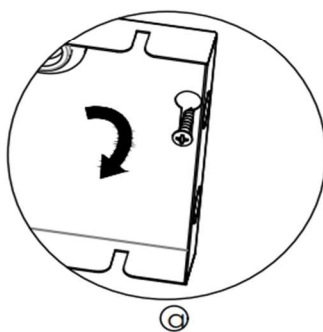

③ Please open the holes on both sides to through the AC cable.

Can through the AC cable on the central hole

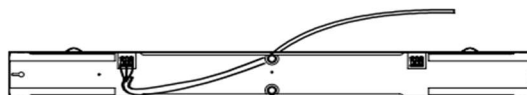

Reserved cable outlet hole

Wiring is shown in the following figure

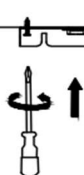
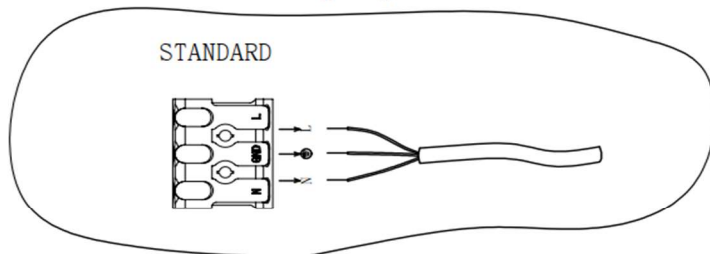

Align the top buckle with the mounting holes. After adjusting the positions, tighten two screws to secure the top buckle



