

EPSILON R

[FI] Asennusohje
 [UK] Installation instruction
 [SE] Installationsanvisning

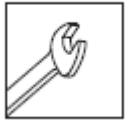

IP20

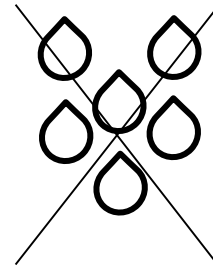

MODEL	Epsilon R 48W	Epsilon R 80W
PRODUCT CODE	GLER0104860	GLER0108090
WEIGHT	6,65 kg	11,9 kg

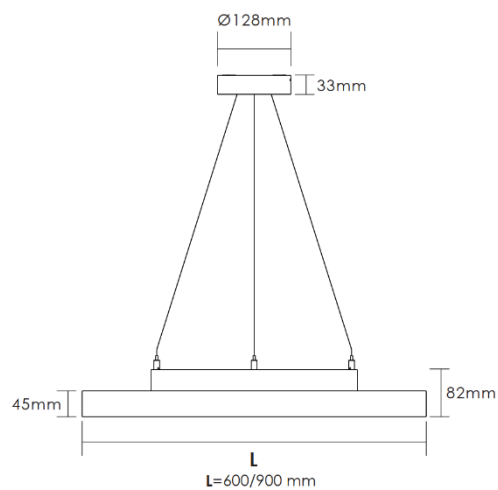
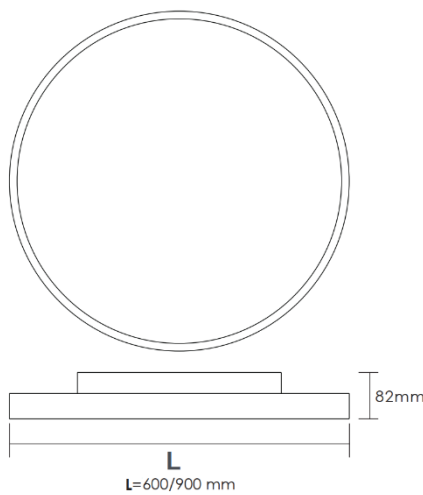

Greenled Oy
 Tarjusojantie 12-14
 FI-90440 Kempele

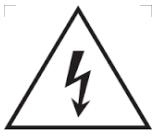

Turvallisuusvaroitukset:

Ennen asennusta tai huoltotyötä kytke valaisin irti sähköverkosta välttääksesi sähköiskun vaaran!

- Asennus / huoltotyön saa tehdä vain valtuutettu henkilö
- Valaisimen asennuksen / huoltotyön saa suorittaa vain pätevä henkilö näiden ohjeiden mukaisesti.
- Valmistaja ei kannu vastuuta valaisimen väärästä käytöstä
- Älä katso suoraan päällä olevaan valaisimeen
- Valaisimen valonlähteen saa vaihtaa ainoastaan Greenled, Greenledin valtuuttama huoltaja tai vastaavan pätevyyden omaava henkilö

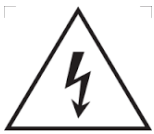

Safety notes:

Before installation or change work disconnect the power to reduce electrical shock risk!

- Installation / maintenance can only be done by a skilled personnel
- Installation / maintenance of luminaire must be performed by qualified person following the instructions given in the instruction set
- The manufacturer bears no liability for damage caused by inappropriate use or application
- Do not stare at the operating light source
- The light source contained in this luminaire shall only be replaced by the Greenled or Greenled's service agent or a similar qualified person

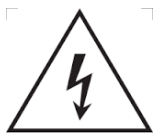

Säkerhetsvarningar:

Koppla alltid bort armaturen från elnätet i samband med installation ti den som använder armaturen.

- Installations- och underhållsarbeten får endast utföras av en behörig installatör
- Installations-/underhållsarbetet får endast utföras enligt dessa anvisningar av en person med tillräckliga kunskaper
- Tillverkaren ansvarar ej för felaktig användning av armaturen
- Titta aldrig rakt in i en påslagen armatur
- Ljuskällan inuti armaturen får endast bytas av antingen Greenled, en Greenled-auktoriserad servicetekniker eller en person med motsvarande kompetens

EPSILON R

[FI] Asennusohje
[UK] Installation instruction
[SE] Installationsanvisning



Ohjauspiirin on oltava peruseristetty verkkojännitteestä
The control circuit must be basic insulated from the mains voltage
Styrkretsen måste vara grundisolerad från nätspänningen

1. Kattoasennus, Surface installation, Takmontering

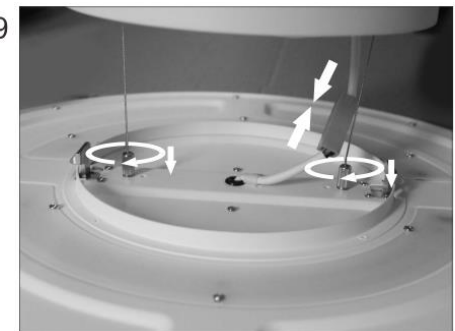
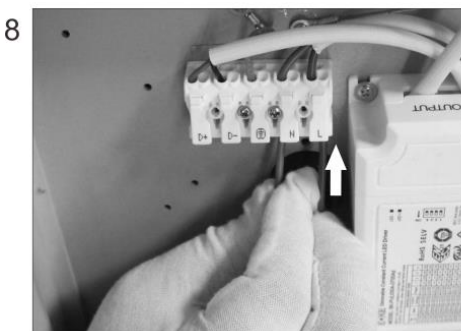
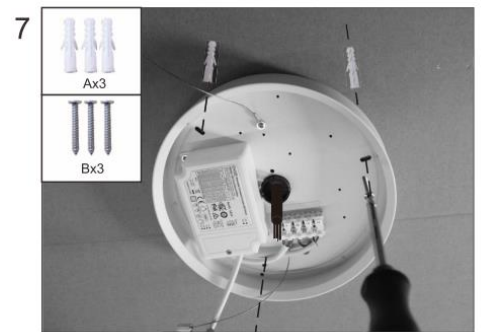
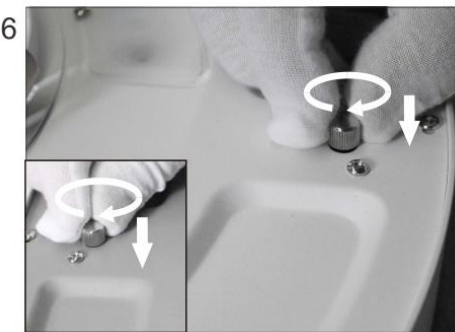
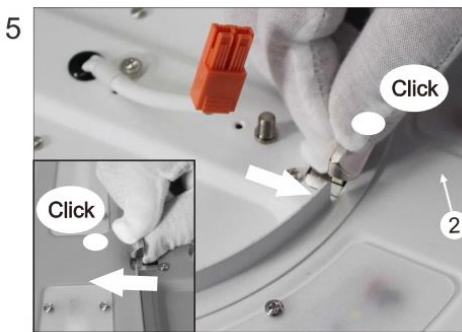
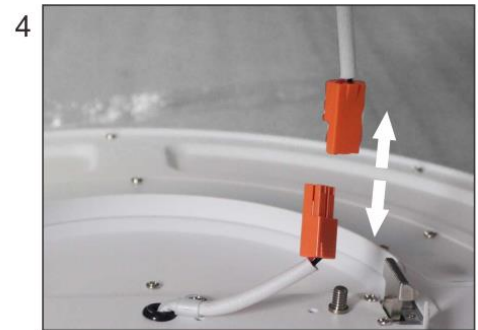
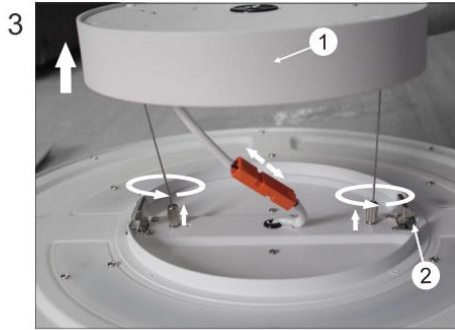
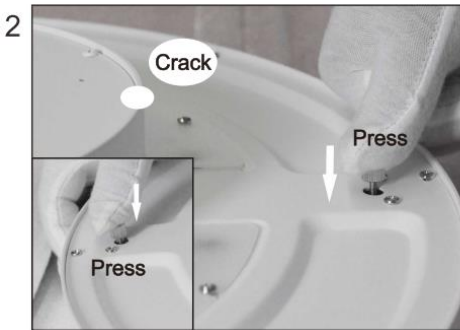
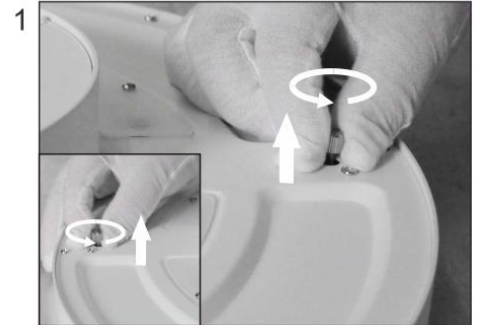
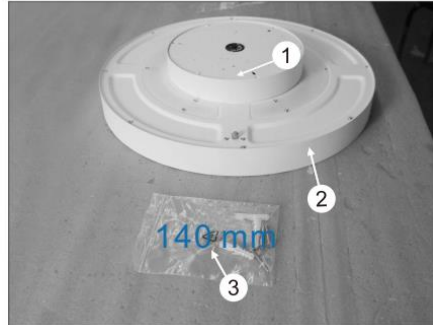
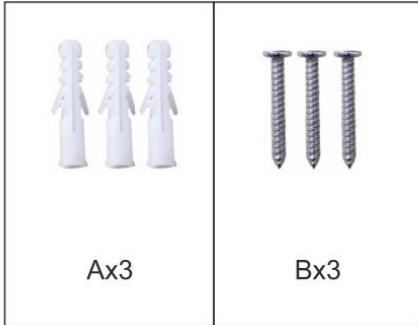

2. Vaijerikiinnitys, Wire installation, Vajerupphängning



Ohjauspiirin on oltava peruseristetty verkkojännitteestä
 The control circuit must be basic insulated from the mains voltage
 Styrkretsen måste vara grundisolerad från nätspänningen

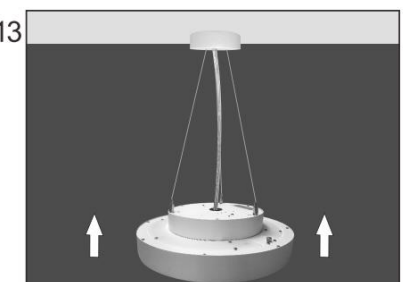
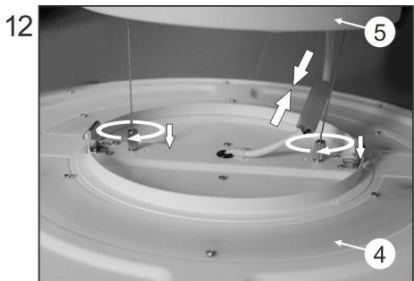
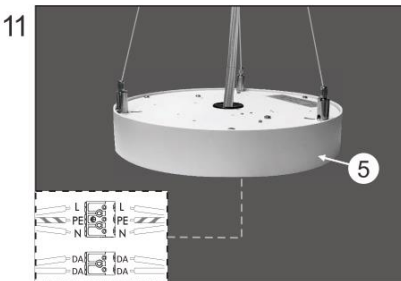
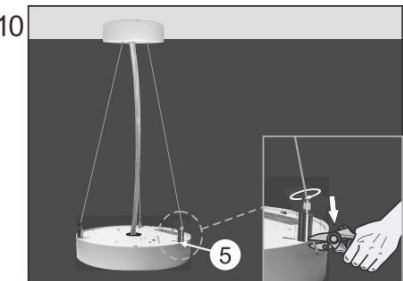
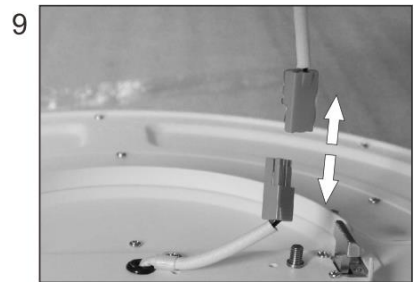
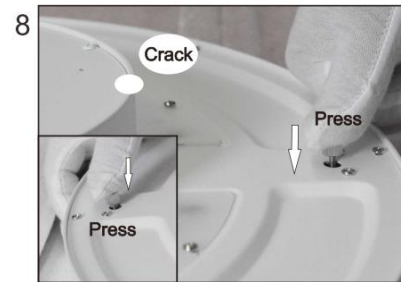
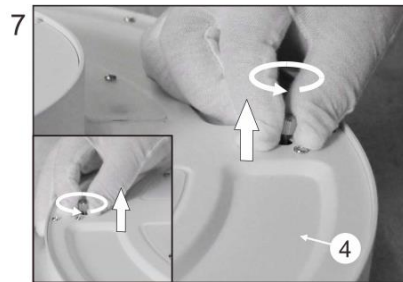
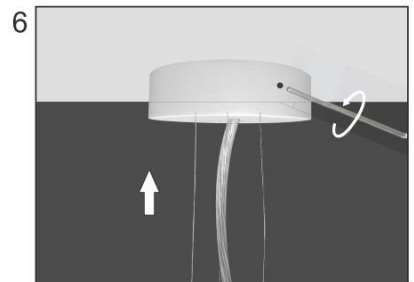
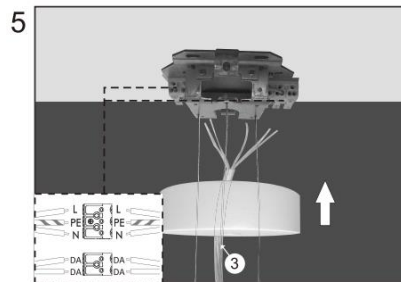
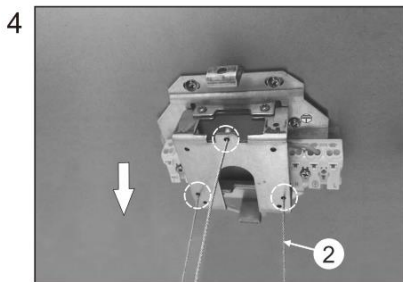
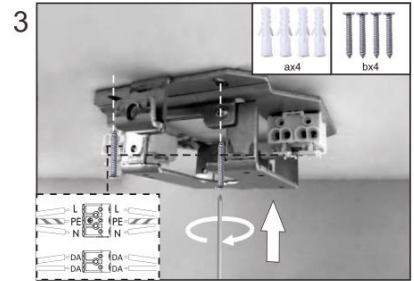
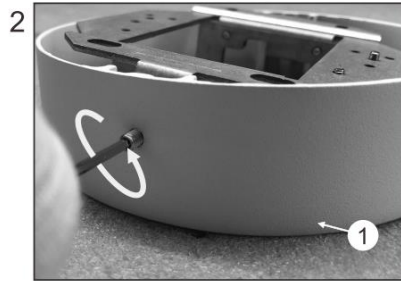
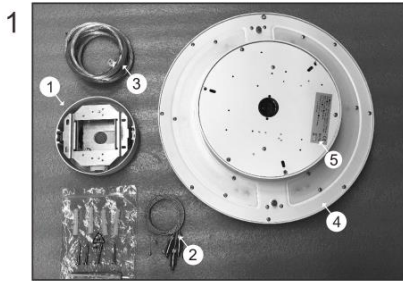

FI

Nämä ohjeet tulee säilyttää ja luovuttaa kiinteistön käyttäjälle.

UK

It is appropriate that this information is passed on to the user of the installation.

SE

Det är lämligt att denna information överlämnas till användaren av anläggningen.

